

de antonio
YACHTS



The most powerful and stylish navigation to date.

de antonio

YACHTS

De Antonio Yachts was born from the passion for the sea and design of its founders, from the interest to innovate and build boats with simple and vanguard lines, that provide new solutions and concepts that improve efficiency, usability and performance. A brand aimed for demanding boat owners looking for something new and different that exceeds their expectations. Boats powered by innovation, to live the sea with style, sportiness and comfort.

De Antonio Yachts nació de la pasión de sus fundadores por el mar y el diseño, con el interés de innovar creando barcos de líneas simples y vanguardistas que ofrezcan nuevas soluciones y conceptos que mejoren la eficiencia, la facilidad de uso y las prestaciones. Una marca dirigida a propietarios de embarcaciones exigentes que buscan algo nuevo y diferente que supere sus expectativas. Barcos impulsados por la innovación, para vivir el mar con estilo, deportividad y comodidad.



E23

The E23 is the brand's first 100% electric boat, the beginning of a new era.

An innovative model, which bases its concept on maximum efficiency. Its compact proportions with catamaran architecture integrating a "foil" between its hulls, give it unique emission-free sailing performance in its segment while offering a practical and comfortable space on deck with a careful design in many details and finishes.

A model that combines cutting-edge technology and design. The new E23 has been chosen, by the organization of the most important sailing competition in the world, to be the Official Electric Boat of the 37th Edition of the America's Cup to be held in Barcelona in 2024.

El E23 es el primer barco 100% eléctrico de la marca, el inicio de una nueva era.

Un modelo innovador, que basa su concepto en la máxima eficiencia. Sus compactas proporciones con arquitectura de catamarán integrando un "foil" entre sus cascos, lo dotan de unas prestaciones de navegación sin emisiones únicas en su segmento al mismo tiempo que ofrece un práctico y confortable espacio en cubierta con un cuidado diseño en numerosos detalles y acabados.

Un modelo que aúna tecnología y diseño de vanguardia. El nuevo E23 ha sido el elegido por la organización de la competición a vela más importante de mundo para ser el Barco Eléctrico Oficial de la 37 Edición de la America's Cup que se celebrará en Barcelona en 2024.

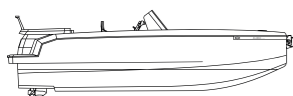

OFFICIAL ELECTRIC BOAT OF 37 TH AMERICA'S CUP





TECHNICAL SPECIFICATIONS / ESPECIFICACIONES TÉCNICAS

OVERALL LENGTH / <i>ESLORA TOTAL</i>	7,20 m	ELECTRIC OUTBOARD ENGINE / <i>MOTOR ELÉCTRICO FUERABORDA</i>	1 uds.
WATERLINE LENGTH / <i>ESLORA TOTAL CON PLATAFORMA XL OPCIONAL</i>	6,40 m	MAXIMUM POWER	50 kW / 68 hp
BEAM / <i>MANGA</i>	2,30 m	BATTERY CAPACITY / <i>DEPÓSITO DE COMBUSTIBLE</i>	40 kWh
DRAFT / <i>CALADO</i>	0,40 m	DISPLACEMENT / <i>DESPLAZAMIENTO</i>	1.450 Kg
PASSENGERS / <i>OCUPANTES</i>	8 pax		



HIDDEN ELECTRIC OUTBOARD ENGINE

MOTOR ELÉCTRICO FUERABORDA OCULTO

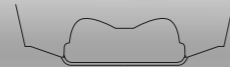

INTEGRATED FOIL

FOIL INTEGRADO

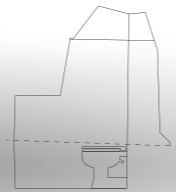

STORAGE CABIN *WC OPTIONAL

CABINA DE ALMACENAJE *INODORO OPCIONAL

POWERING / PROPULSIÓN

TORQUEEDO OUTBOARD ENGINES / TORQUEEDO FUERABORDA ELÉCTRICO

1 X 50 KW

OUTBOARD DEEP BLUE 50RXL

STANDARD EQUIPMENT / EQUIPAMIENTO DE SERIE

CASTED ALLOY FOIL SYSTEM	SISTEMA FOIL EN FUNDICIÓN DE ALUMINIO
WHITE COLOUR HULL RAL 9016	CASCO COLOR BLANCO RAL 9016
SPRAYHOOD	CAPOTA ANTIROCIÓN
NON-SKID DECK FINISH	CUBIERTA CON ACABADO ANTIDESLIZANTE
CUSHION & UPHOLSTERY PREMIUM MORBERN SUNDANCE® HERM	COJINES Y TAPICERÍA PREMIUM MORBERN SUNDANCE® HERM
PILOT BENCH SEATS IN MORBERN ALLANTE® GREY UPHOLSTERY	ASIENTOS BANCO PILOTO EN TAPICERÍA MORBERN ALLANTE® GREY
FOLDING BACKREST	RESPALDO PLEGABLE ASIENTOS PILOTO
SWIMMING LADDER	ESCALERA DE BAÑO
HORN	BOCINA
COMPOSITE FLAGPOLE	ASTA DE BANDERA
RETRACTABLE CLEATS IN STAINLESS STEEL	CORNAMUSAS RETRÁCTILES DE ACERO INOXIDABLE
GRAPNEL ANCHOR + 7M CHAIN + 28M ROPE	ANCLA DE REZÓN CON 7M DE CADENA Y 28M DE CABO
AC SHORE POWER AND CABLE /BATTERY CHARGER	TOMA DE TIERRA Y CABLE / CARGADOR DE BATERÍA
AUDIO SYSTEM FUSION RA60 (2 SPEAKERS)	SISTEMA DE AUDIO FUSION SERIE RA-60 (2 ALTAVOCES)
NAVIGATION SYSTEM SCREEN SIMRAD NSX (9")	SISTEMA DE NAVEGACIÓN SIMRAD (9")
LED NAVIGATION LIGHTS	LUCES DE NAVEGACIÓN LED
OUTLET 12V	ENCHUFE 12V
INTERIOR FUSE PANEL	PANEL INTERIOR DE FUSIBLES
BILGE PUMPS	BOMBAS DE ACHIQUE
50 AH SERVICE BATTERY	BATERÍA DE SERVICIO DE 50 AH
INTERIOR STORAGE AREA (1,2 X 0,8 X 1,2 METERS)	ESPACIO DE ALMACENAMIENTO INTERIOR (1,2 X 0,8 X 1,2 M)
TWO AFT EXTERIOR AREA STORAGE BOXES	DOS ESPACIOS DE ALMACENAMIENTO EXTERIOR



*CABIN WC OPT. *INODORO EN CABINA OPC.

D29

Building on the style and features of one of the most iconic models in our range, the D28, we have taken a step further. The D29 is a vessel that offers unique performance in its category thanks to its high-performance hull. It provides a unique sailing experience with dual panoramic screens.

This model allows for customization with multiple possibilities, available in both hardtop and softtop versions. Its deck is designed to maximize space and provide unparalleled comfort and experience.

Furthermore, the interior boasts a surprising forward cabin with a double bed and a full bathroom. In short, it is a 29-foot “walk around” boat filled with exclusive and original details to enjoy the sea like never before.

A partir de las líneas de estilo y prestaciones de uno de los modelos más emblemáticos de nuestra gama, el D28, hemos dado un paso más. El D29 es una embarcación que presenta unas prestaciones únicas en su categoría gracias a su casco de alto rendimiento. Una experiencia única de navegación con doble pantalla panorámica.

Es un modelo que permite personalizarlo con múltiples posibilidades, ya sea en sus versiones hardtop y softop. Su cubierta está concebida para aprovechar al máximo el espacio y proporcionar un confort y experiencia inigualable.

Además, el interior también ha sido creado con una sorprendente cabina de proa con cama doble y baño completo. En definitiva, un barco de 29 pies” walk around” lleno de detalles exclusivos y originales para disfrutar del mar como nunca.

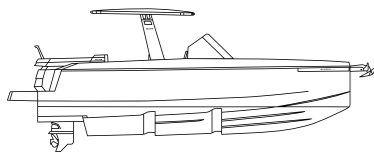



TECHNICAL SPECIFICATIONS / ESPECIFICACIONES TÉCNICAS

LENGTH OVERALL / <i>ESLORA TOTAL</i>	7,99 m	MAXIMUM POWER / <i>POTENCIA MÁXIMA</i>	400 HP
LENGTH OVERALL WITH PLATFORM XL OPTION / <i>ESLORA TOTAL CON PLATAFORMA XL OPCIONAL</i>	8,49 m	FUEL TANK / <i>DEPÓSITO DE COMBUSTIBLE</i>	440 L
BEAM / <i>MANGA</i>	2,99 m	WATER TANK / <i>DEPÓSITO DE AGUA DULCE</i>	88 L
DEPTH / <i>CALADO</i>	0,50 m	DISPLACEMENT / <i>DESPLAZAMIENTO</i>	2.500 Kg
PASSENGERS / <i>OCUPANTES</i>	10 pax		
OUTBOARD ENGINES / <i>MOTORES FUERABORDA</i>	2 uds.		



HIDDEN OUTBOARD ENGINES

MOTORES FUERABORDA OCULTOS

COMPLETE BATHROOM

BAÑO COMPLETO

MOTORIZATION / MOTORIZACIÓN

1 X 300 HP MERCURY V-8 VERADO	(4 STROKE) OUTBOARD / (4 TIEMPOS) FUERABORDA
1 X 350 HP MERCURY V-10 VERADO	(4 STROKE) OUTBOARD / (4 TIEMPOS) FUERABORDA
1 X 400 HP MERCURY V-10 VERADO	(4 STROKE) OUTBOARD / (4 TIEMPOS) FUERABORDA
2 X 200 HP MERCURY V-6 FOURSTROKE	(4 STROKE) OUTBOARD / (4 TIEMPOS) FUERABORDA

ACTIVE TRIM MERCURY MARINE®

STANDARD EQUIPMENT / EQUIPAMIENTO DE SERIE

WHITE COLOR HULL	CASCO COLOR BLANCO
ARTIFICIAL TEAK DECK FLEXITEEK® SCRUBBED WITH BLACK LINES	CUBIERTA DE TECA SINTÉTICA FLEXITEEK® SCRUBBED Y LÍNEAS NEGRAS
ANCHOR SUPPORT, ANCHOR, CHAIN AND ELECTRIC WINCH	SOPORTE DE ANCLA, ANCLA, CADENA Y MOLINETE ELÉCTRICO
LED NAVIGATION LIGHTS	LUCES DE NAVEGACIÓN LED
TABLE ON STERN	MESA FIJA EN POPA
RETRACTABLE TABLE ON BOW	MESA RETRÁCTIL EN PROA
SWIMMING LADDER	ESCALERA DE BAÑO
HANDHOLDS WITH FABRIC FINISHES	ASIDEROS CON ACABADOS EN TELA
FLAGPOLE	ASTA DE BANDERA
USB PLUG 12 V OUTLET	ENCHUFE USB 12V
CUSHIONS AND UPHOLSTERY MORBERN SUNDANCE® HERM	COJINES Y TAPICERÍA MORBERN SUNDANCE® HERM
SET OF TWO FENDERS (SPECIAL D28 MODEL)	JUEGO DE DOS DEFENSAS (MODELO ESPECIAL D28)
RETRACTABLE CLEATS IN ALUMINIUM	CORNAMUSAS RETRÁCTILES DE ALUMINIO
CARBON TRIMS ON BOWS AND SIDES	EMBELLECEDORES DE CARBONO EN LAS AMURAS Y COSTADOS
NAVIGATION SYSTEM SIMRAD (7")	SISTEMA DE NAVEGACIÓN SIMRAD (7")
AUDIO SYSTEM FUSION RA55 (4 SPEAKERS)	SISTEMA DE AUDIO FUSION RA55 (4 ALTAVOCES)
BILGE PUMPS	BOMBAS DE ACHIQUE
SHOWER ON DECK	DUCHA AGUA DULCE EN CUBIERTA
BOW CABIN WITH DOUBLE BED AND COMPLETE BATHROOM	CABINA DE PROA CON CAMA DOBLE Y BAÑO COMPLETO



D32

O P E N

The D32 Open, with a length of 10 meters, joins the new generation in design and performance of the brand that began with the award-winning D36 model. Its proportions and exterior lines and its careful definition in every detail, enhance its modern and sporty character that together with the evolved architecture of its high-performance hull give the model a comfortable navigation, with low consumption and high-speed performance.

The “walkaround” deck has a unique distribution of spaces for its length, capable of incorporating, in addition to generous sunbathing areas and benches with central table, a practical outdoor galley. The interior is distributed in an open space with two double berths and a separate bathroom.

The high level of quality and definition of its finishes together with its performance make the D32 Open a compact and sophisticated “day boat” ideal for all audiences.

El D32 Open con una eslora de 10 metros se suma a la nueva generación en diseño y prestaciones de la marca que se inició con el premiado modelo D36. Sus proporciones y líneas exteriores y su cuidada definición en cada detalle, potencian su carácter moderno y deportivo que junto a la evolucionada arquitectura de su casco de alto rendimiento dotan al modelo una navegación confortable, con bajo consumo y altas prestaciones de velocidad.

La cubierta de tipología “walkaround” presenta una distribución de espacios única en su eslora, capaz de incorporar además de generosas zonas de solárium y bancos con mesa central una práctica cocina exterior. El interior se distribuye en un espacio abierto con dos camas dobles y un baño independiente.

El alto nivel de calidad y definición de sus acabados junto a sus prestaciones convierten al D32 Open en un “day boat” compacto y sofisticado ideal para todos los públicos.





TECHNICAL SPECIFICATIONS / ESPECIFICACIONES TÉCNICAS

LENGTH OVERALL WITH PLATFORM / <i>ESLORA TOTAL CON PLATAFORMA</i>	9,9 m	MINIMUM POWER / <i>POTENCIA MÍNIMA</i>	400 HP
BEAM / <i>MANGA</i>	3,20 m	MAXIMUM POWER / <i>POTENCIA MÁXIMA</i>	600 HP
DEPTH / <i>CALADO</i>	0,68 m	FUEL TANK / <i>DEPÓSITO DE COMBUSTIBLE</i>	650 L
PASSENGERS / <i>OCUPANTES</i>	10 pax	WATER TANK / <i>DEPÓSITO DE AGUA DULCE</i>	100 L
OUTBOARD ENGINES / <i>MOTORES FUERABORDA</i>	2 uds.	DISPLACEMENT / <i>DESPLAZAMIENTO</i>	3.900 Kg



HIDDEN OUTBOARD ENGINES

MOTORES FUERABORDA OCULTOS

MOTORIZATION / MOTORIZACIÓN

2 X 200 HP MERCURY V-6 FOURSTROKE	(4 STROKE) OUTBOARD / (4 TIEMPOS) FUERABORDA
2 X 225 HP MERCURY V-6 FOURSTROKE	(4 STROKE) OUTBOARD / (4 TIEMPOS) FUERABORDA
2 X 250 HP MERCURY V-8 VERADO	(4 STROKE) OUTBOARD / (4 TIEMPOS) FUERABORDA
2 X 300 HP MERCURY V-8 VERADO	(4 STROKE) OUTBOARD / (4 TIEMPOS) FUERABORDA

ACTIVE TRIM MERCURY MARINE®
JOYSTICK PILOTING SYSTEM (JPO) MERCURY

STANDARD EQUIPMENT / EQUIPAMIENTO DE SERIE

WHITE COLOR HULL WITH SOFT-TOP	CASCO COLOR BLANCO CON SOFT-TOP
ARTIFICIAL TEAK DECK FLEXITEEK® SCRUBBED WITH BLACK LINES	CUBIERTA DE TECA SINTÉTICA FLEXITEEK® SCRUBBED Y LINEAS NEGRAS
ANCHOR SUPPORT, ANCHOR, CHAIN AND ELECTRIC WINCH	SOPORTE DE ANCLA, ANCLA, CADENA Y MOLINETE ELÉCTRICO
LED NAVIGATION LIGHTS	LUCES DE NAVEGACIÓN LED
LED DECORATIVE LIGHTS ON DECK	LUCES DECORATIVAS LED EN CUBIERTA
TABLE DECK	MESA DE CUBIERTA
SWIMMING LADDER	ESCALERA DE BAÑO
CARBON TRIMS ON BOWS AND REAR SPEAKERS	EMBELLECEDORES DE CARBONO EN LAS AMURAS Y ALTAVOCES POSTERIORES
FIBER FLAGPOLE	ASTA DE BANDERA
RETRACTABLE CLEATS IN ALUMINIUM	CORNAMUSAS RETRACTILES DE ALUMINIO
COMPLETE KITCHEN EXTERIOR (FRIDGE 49L, SINK, VITROCERAMIC COOKTOP)	COCINA EXTERIOR (NEVERA 49L, FREGADERO, PLACA VITROCERÁMICA)
OUTLET 12V	ENCHUFE 12V (USB Y MECHERO)
CUSHION AND UPHOLSTERY PREMIUM MORBERN SUNDANCE® HERM	COJINES Y TAPICERÍA PREMIUM MORBERN SUNDANCE®HERM
AUDIO SYSTEM FUSION RA-60 (4 SPEAKERS)	SISTEMA DE AUDIO FUSION SERIE RA-60 (4 ALTAVOCES)
NAVIGATION SYSTEM SIMRAD (12")	SISTEMA DE NAVEGACIÓN SIMRAD (12")
PILOT BENCH SEATS IN MORBERN ALLANTE® GREY UPHOLSTERY	ASIENTOS BANCO PILOTO EN TAPICERÍA MORBERN ALLANTE® GREY
HORN	BOCINA
BILGE PUMPS	BOMBAS DE ACHIQUE
AC SHORE POWER AND CABLE / BATTERY CHARGER	TOMA DE TIERRA Y CABLE / CARGADOR DE BATERÍA
SHOWER ON DECK	DUCHA AGUA DULCE EN CUBIERTA
WINDOWS ON HULL SIDES (STERN AND BOW CABIN)	VENTANAS LATERALES EN CASCO (CABINA POPA Y PROA)
BOW CABIN WITH DOUBLE BED	CABINA EN PROA CON CAMA DOBLE
STERN CABIN	CABINA EN POPA
COMPLETE BATHROOM (ELECTRIC WC)	BAÑO COMPLETO (WC ELÉCTRICO)





D36

O P E N

The D36 is the new mid-size model in the range that gathers together the brand's experience in the development of the latest models and concentrates in a single version the best of the successful D34 in its Open and Cruiser variants.

A very complete boat in its length, with a high-performance hull with a pronounced V and two lines of steps, a large space on the deck with a walkaround distribution with an innovative modular interior and a complete independent bathroom. The options "Hardtop" and "High windshield" offer the possibility of configuring a semi cabin version where you can navigate protected.

An evolved, sophisticated and sporty design. An avant-garde boat that will set a trend.

El D36 es el nuevo modelo medio de la gama que recoge la experiencia de la marca en el desarrollo de los últimos modelos y concentra en una sola versión lo mejor del exitoso D34 en sus variantes Open y Cruiser.

Un barco muy completo en su eslora, con un casco de alto rendimiento de pronunciada V y dos líneas de "steps", gran espacio en cubierta con distribución "walkaround" con un innovador interior modulable y un completo baño independiente. Los opcionales "Hardtop" y "Parabrisas alto" ofrecen la posibilidad de configurar una versión semi cabinada dónde poder navegar protegido.

Un evolucionado diseño, sofisticado y deportivo. Un barco de vanguardia que marcará tendencia.

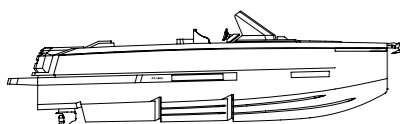



TECHNICAL SPECIFICATIONS / ESPECIFICACIONES TÉCNICAS

LENGTH OVERALL / <i>ESLORA TOTAL</i>	10,30 m	MINIMUM POWER / <i>POTENCIA MÍNIMA</i>	600 HP
LENGTH OVERALL WITH PLATFORM XL OPTION / <i>ESLORA TOTAL CON PLATAFORMA XL OPCIONAL</i>	11,15 m	MAXIMUM POWER / <i>POTENCIA MÁXIMA</i>	900 HP
BEAM / <i>MANGA</i>	3,40 m	FUEL TANK / <i>DEPÓSITO DE COMBUSTIBLE</i>	850 L
DEPTH / <i>CALADO</i>	0,70 m	WATER TANK / <i>DEPÓSITO DE AGUA DULCE</i>	150 L
PASSENGERS / <i>OCUPANTES</i>	12 pax	DISPLACEMENT / <i>DESPLAZAMIENTO</i>	5.300 Kg
OUTBOARD ENGINES / <i>MOTORES FUERABORDA</i>	2 uds.		

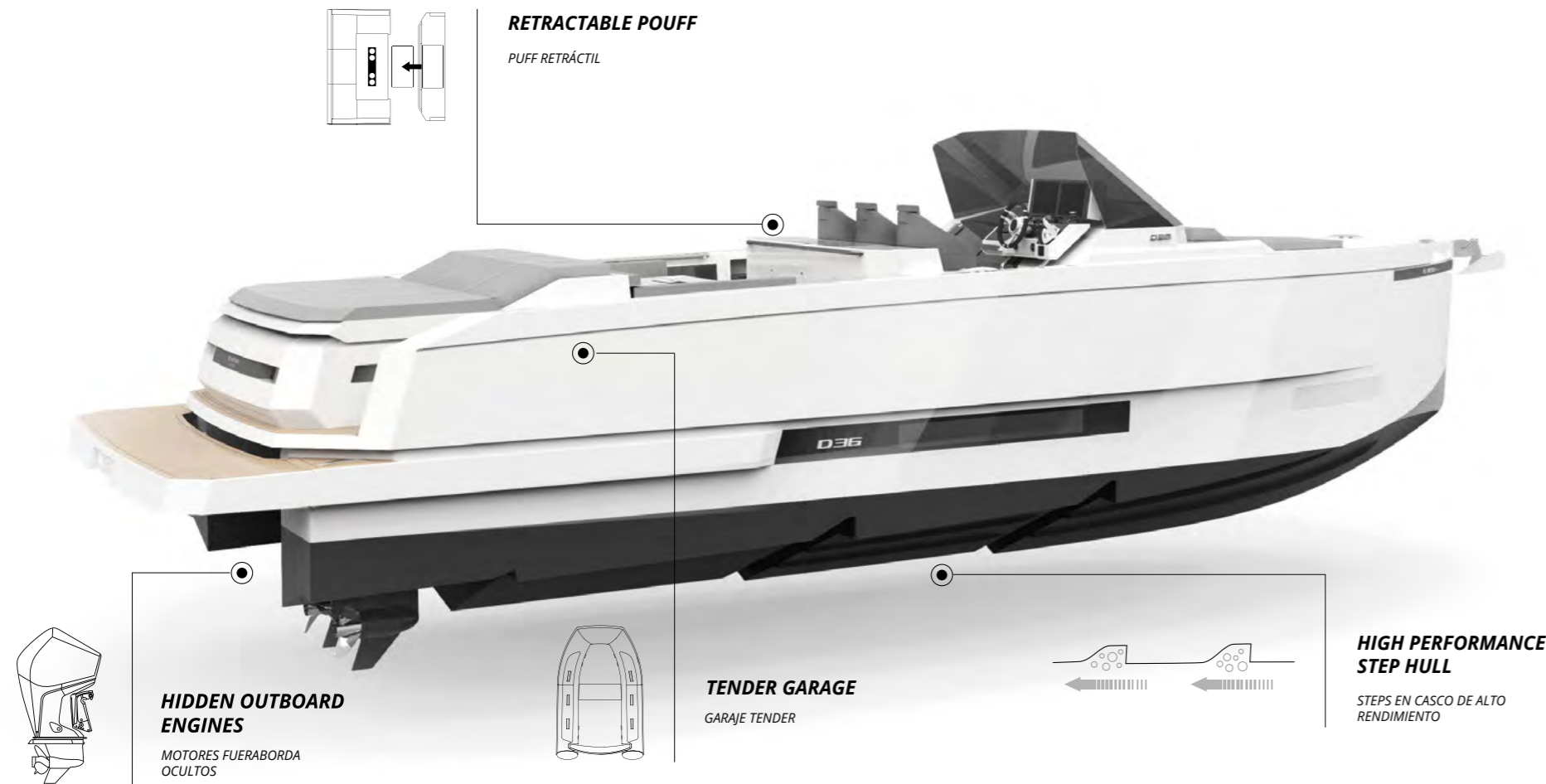

MOTORIZATION / MOTORIZACIÓN

2 X 300 HP MERCURY V-8 VERADO®	(4 STROKE) OUTBOARD / (4 TIEMPOS) FUERABORDA
2 X 350 HP MERCURY V-10 VERADO®	(4 STROKE) OUTBOARD / (4 TIEMPOS) FUERABORDA
2 X 400 HP MERCURY V-10 VERADO®	(4 STROKE) OUTBOARD / (4 TIEMPOS) FUERABORDA
ACTIVE TRIM MERCURY MARINE®	
JOYSTICK PILOTING SYSTEM (JPO) MERCURY (OPTIONAL)	

STANDARD EQUIPMENT / EQUIPAMIENTO DE SERIE

WHITE COLOR HULL	CASCO COLOR BLANCO
ARTIFICIAL TEAK DECK FLEXITEEK® SCRUBBED WITH BLACK LINES	CUBIERTA DE TECA SINTÉTICA FLEXITEEK® SCRUBBED Y LÍNEAS NEGRAS
ANCHOR SUPPORT, ANCHOR, CHAIN AND ELECTRIC WINCH	SOORTE DE ANCLA, ANCLA, CADENA Y MOLINETE ELÉCTRICO
LED NAVIGATION LIGHTS	LUCES DE NAVEGACIÓN LED
LED DECORATIVE LIGHTS ON DECK	LUCES DECORATIVAS LED EN CUBIERTA
TABLE ON DECK	MESA DE CUBIERTA
SWIMMING LADDER	ESCALERA DE BAÑO
CARBON TRIMS ON BOWS	EMBELLECEDORES DE CARBONO EN LAS AMURAS
FLAGPOLE	ASTA DE BANDERA
USB PLUG 12 V OUTLET	ENCHUFE USB 12V
EXTERIOR KITCHEN (FRIDGE, SINK, VITROCERAMIC COOKTOP)	COCINA EXTERIOR (NEVERA, FREGADERO, PLACA VITROCERÁMICA)
PILOT BENCH SEATS IN MORBERN ALLANTE® GREY UPHOLSTERY	ASIENTOS BANCO PILOTO EN TAPICERÍA MORBERN ALLANTE® GREY
CUSHION AND PREMIUM UPHOLSTERY MORBERN SUNDANCE® HERM	TAPICERÍA PREMIUM MORBERN SUNDANCE® HERM
RETRACTABLE CLEATS IN ALUMINIUM	CORNAMUSAS RETRÁCTILES DE ALUMINIO
AUDIO SYSTEM FUSION RA60 (4 SPEAKERS)	SISTEMA DE AUDIO FUSION RA60 (4 ALTAVOCES)
NAVIGATION SYSTEM SIMRAD (9")	SISTEMA DE NAVEGACIÓN SIMRAD (9")
HORN	BOCINA
BILGE PUMPS	BOMBAS DE ACHIQUE
AC SHORE POWER AND CABLE / BATTERY CHARGER	TOMA DE TIERRA Y CABLE / CARGADOR DE BATERÍA
SHOWER ON DECK	DUCHA AGUA DULCE EN CUBIERTA
WINDOWS ON HULL SIDES (STERN AND BOW CABIN)	VENTANAS LATERALES EN CASCO (CABINA POPA Y PROA)
BOW CABIN WITH DOUBLE BED (140 CM X 190 CM)	CABINA EN PROA CON CAMA DOBLE (140 X 190 CM)
STERN CABIN WITH TRIPLE BED IN U SHAPE	CABINA EN POPA CON CAMA TRIPLE EN FORMA DE U
COMPLETE BATHROOM (ELECTRIC WC)	BAÑO COMPLETO (WC ELÉCTRICO)



de antonio
YACHTS



OFFICIAL SUPPLIER

D37

ALINGHI RED BULL RACING

The D37 Alinghi Red Bull Racing is a tribute to the prestigious sailing racing team Alinghi, winner of the America's Cup representing the Swiss club Société Nautique de Genève.

The participation in the 37th Edition of the America's Cup to be held in Barcelona in 2024, has led to the collaboration of De Antonio Yachts with the team to create a special design for a Limited Edition of 37 exclusive units.

The model is equipped with two Mercury 400hp Racing version engines that give it a high performance of sportiness in navigation. Its exterior and interior, in full navy blue, the official color of the team, combined with red details, special upholstery finishes, as well as bucket seats and steering wheel in navy blue leather and red stitching and numerous details in carbon fiber and inscriptions with the logos of the racing team make this version, the perfect model for fans of the team and lovers of limited editions who appreciate the value of unique pieces.

El D37 Alinghi Red Bull Racing es un tributo al prestigioso equipo de regatas a vela Alinghi, ganador de la America's Cup representando al club suizo Société Nautique de Genève.

En motivo de la participación en la 37th Edición de la America's Cup que se celebrará en Barcelona en 2024, De Antonio Yachts en colaboración con el equipo ha creado un diseño especial para una Edición Limitada de 37 exclusivas unidades.

El modelo equipa dos motores Mercury 400hp versión Racing que le confieren unas altas prestaciones de deportividad en la navegación. Su exterior e interior, en completo tono azul marino, color oficial del equipo, combinado con detalles en rojo, acabados de tapicería especiales, así como asientos tipo bucket y volante en piel azul marino y pespunte en rojo y numerosos detalles en fibra de carbono e inscripciones con los logos del equipo de competición hacen de esta versión, el modelo perfecto para los fans del equipo y los amantes de ediciones limitadas que saben apreciar el valor de piezas únicas.





D42

O P E N

The D42 offers the best of navigation with an incomparable stern platform and the option of being able to regulate its height and adjust it to the sea level. Its spectacular walk-around design with large sundecks, a lounge area convertible in 3 different configurations, together with the exterior kitchen, make it unique. The D42 exceeds all expectations, with its interior habitability that stands out for its spaciousness, smart solutions such as a central garage for a small tender, and finally the successful and recognized brand innovation of hidden outboard motorization. An ideal 12-meter family cruiser with sporty features and an exceptional design.

El D42 ofrece lo mejor de la navegación con una incomparable plataforma de popa y con la opción de poder regular su altura para ajustarla hasta el nivel del mar. Su espectacular diseño walkaround con grandes solárium, la zona de estar tipo lounge y convertible en tres configuraciones distintas junto a la cocina exterior lo hacen único. El D42 supera todas las expectativas, con su habitabilidad interior que se destaca por su amplitud, soluciones como un garaje central para una pequeña auxiliar junto a la exitosa y reconocida innovación de la marca en la motorización fueraborda oculta. Un ideal crucero familiar de 12 metros con prestaciones deportivas y un diseño excepcional.

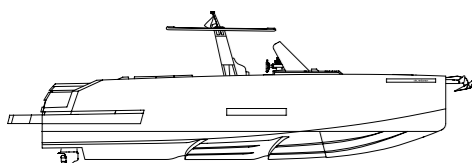



TECHNICAL SPECIFICATIONS / ESPECIFICACIONES TÉCNICAS

LENGTH OVERALL / <i>ESLORA TOTAL</i>	12,10 m	MINIMUM POWER / <i>POTENCIA MÍNIMA</i>	900 HP
LENGTH OVERALL WITH PLATFORM XL OPTION / <i>ESLORA TOTAL CON PLATAFORMA XL OPCIONAL</i>	12,64 m	MAXIMUM POWER / <i>POTENCIA MÁXIMA</i>	1.200 HP
BEAM / <i>MANGA</i>	3,99 m	FUEL TANK / <i>DEPÓSITO DE COMBUSTIBLE</i>	1.300 L
DEPTH / <i>CALADO</i>	0,70 m	WATER TANK / <i>DEPÓSITO DE AGUA DULCE</i>	250 L
PASSENGERS / <i>OCUPANTES</i>	12 pax	DISPLACEMENT / <i>DESPLAZAMIENTO</i>	7.600 Kg
OUTBOARD ENGINES / <i>MOTORES FUERABORDA</i>	3 uds.		



MOTORIZATION / MOTORIZACIÓN

3 X 300 HP MERCURY V-8 VERADO®	(4 STROKE) OUTBOARD / (4 TIEMPOS) FUERABORDA
3 X 350 HP MERCURY V-10 VERADO®	(4 STROKE) OUTBOARD / (4 TIEMPOS) FUERABORDA
3 X 400 HP MERCURY V-10 VERADO®	(4 STROKE) OUTBOARD / (4 TIEMPOS) FUERABORDA
ACTIVE TRIM MERCURY MARINE®	
JOYSTICK PILOTING SYSTEM (JPO) MERCURY® (OPTIONAL)	

STANDARD EQUIPMENT / EQUIPAMIENTO DE SERIE

WHITE COLOR HULL	CASCO COLOR BLANCO
ARTIFICIAL TEAK DECK FLEXITEEK® SCRUBBED WITH BLACK LINES	CUBIERTA DE TECA SINTÉTICA FLEXITEEK® SCRUBBED Y LÍNEAS NEGRAS
ANCHOR SUPPORT, ANCHOR, CHAIN AND ELECTRIC WINCH	SOORTE DE ANCLA, ANCLA, CADENA Y MOLINETE ELÉCTRICO
SOFT-TOP	SOFT -TOP
LED NAVIGATION LIGHTS LOPOLIGHT®	LUCES DE NAVEGACIÓN LED LOPOLIGHT®
LED DECORATIVE LIGHTS ON DECK	LUCES DECORATIVAS LED EN CUBIERTA
TWO RETRACTABLE TABLES	DOS MESAS RETRACTILES
SWIMMING LADDER	ESCALERA DE BAÑO
CARBON TRIMS ON BOWS AND SIDES	EMBELLECEDORES DE CARBONO EN LAS AMURAS Y COSTADOS
FLAGPOLE	ASTA DE BANDERA
RETRACTABLE CLEATS IN ALUMINIUM	CORNAMUSAS RETRACTILES DE ALUMINIO
COMPLETE KITCHEN (FRIDGE, SINK, CERAMIC COOKTOP, MICROWAVE)	COCINA (NEVERA, FREGADERO, VITROCERÁMICA, MICROONDAS)
CUSHIONS AND UPHOLSTERY MORBERN SUNDANCE® HERM	COJINES Y TAPICERÍA MORBERN SUNDANCE® HERM
HANDHOLDS WITH MORBERN SUNDANCE® FINISHES	ASIDEROS CON ACABADOS EN MORBERN SUNDANCE®
AUDIO SYSTEM FUSION R470N (4 SPEAKERS)	SISTEMA DE AUDIO FUSION R470N (4 ALTAVOCES)
NAVIGATION SYSTEM SIMRAD (12")	SISTEMA DE NAVEGACIÓN SIMRAD (12")
VHF RADIO SIMRAD RS20 AND ANTENNA	RADIO VHF SIMRAD RS20 Y ANTENA
USB PLUG 12 V OUTLET	ENCHUFE USB 12V
HORN	BOCINA
BILGE PUMPS	BOMBAS DE ACHIQUE
AC SHORE POWER AND CABLE / BATTERY CHARGER	TOMA DE TIERRA Y CABLE / CARGADOR DE BATERÍA
SHOWER ON DECK	DUCHA AGUA DULCE EN CUBIERTA
WINDOWS ON HULL SIDES (STERN CABIN)	VENTANAS LATERALES EN CASCO (CABINA POPA)
BOW CABIN WITH DOUBLE BED (140 X 190 CM)	CABINA EN PROA CON CAMA DOBLE (140 X 190 CM)
STERN CABIN WITH U SHAPE TRIPLE BED (250 X 300 X 250 CM)	CABINA EN POPA CON SOFA EN U-CAMA TRIPLE (250 X 300 X 250 CM)
COMPLETE BATHROOM (ELECTRIC WC)	BAÑO COMPLETO (WC ELÉCTRICO)





D50

O P E N

The D50 Open, is the ultimate in on-board performance and comfort. Based on the award-winning D46 Open and equipped with 2, 3 or 4 hidden outboard engines, it delivers unrivalled sporty and efficient cruising, exceeding 50 knots with a maximum power output of 1,800hp. Its deck layout offers impressive relaxation areas including the optional convertible Jacuzzi on the bow sundeck.

The interior layout is customizable with 2 or 3 cabins, one of which can be adapted as a skipper's cabin, also offering the option of 1 or 2 bathrooms.

El D50 Open, es el máximo exponente de rendimiento y confort a bordo. Basado en el premiado D46 Open y equipado con 2, 3 o 4 motores fueraborda ocultos, proporciona una navegación deportiva y eficiente sin igual, superando los 50 nudos con una potencia máxima de 1.800cv. Su distribución en cubierta ofrece incluso el opcional de un jacuzzi convertible en el solárium de proa.

La distribución interior personalizable, con 2 o 3 camarotes, uno de ellos adaptable como cabina de patrón, ofreciendo también la opción de 1 o 2 baños.

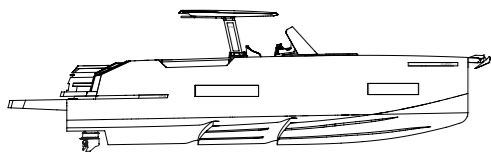



TECHNICAL SPECIFICATIONS / ESPECIFICACIONES TÉCNICAS

LENGTH OVERALL / <i>ESLORA TOTAL</i>	13,10 m	MINIMUM POWER / <i>POTENCIA MÍNIMA</i>	1.200 HP
LENGTH OVERALL WITH PLATFORM OPTION / <i>ESLORA TOTAL CON PLATAFORMA OPCIONAL</i>	14,90 m	MAXIMUM POWER / <i>POTENCIA MÁXIMA</i>	1.600 HP
BEAM / <i>MANGA</i>	4,40 m	FUEL TANK / <i>DEPÓSITO DE COMBUSTIBLE</i>	1.500 L
DEPTH / <i>CALADO</i>	0,70 m	WATER TANK / <i>DEPÓSITO DE AGUA DULCE</i>	350 L
PASSENGERS / <i>OCUPANTES</i>	12 pax	DISPLACEMENT / <i>DESPLAZAMIENTO</i>	11.000 Kg
OUTBOARD ENGINES / <i>MOTORES FUERABORDA</i>	2 o 4 uds.		

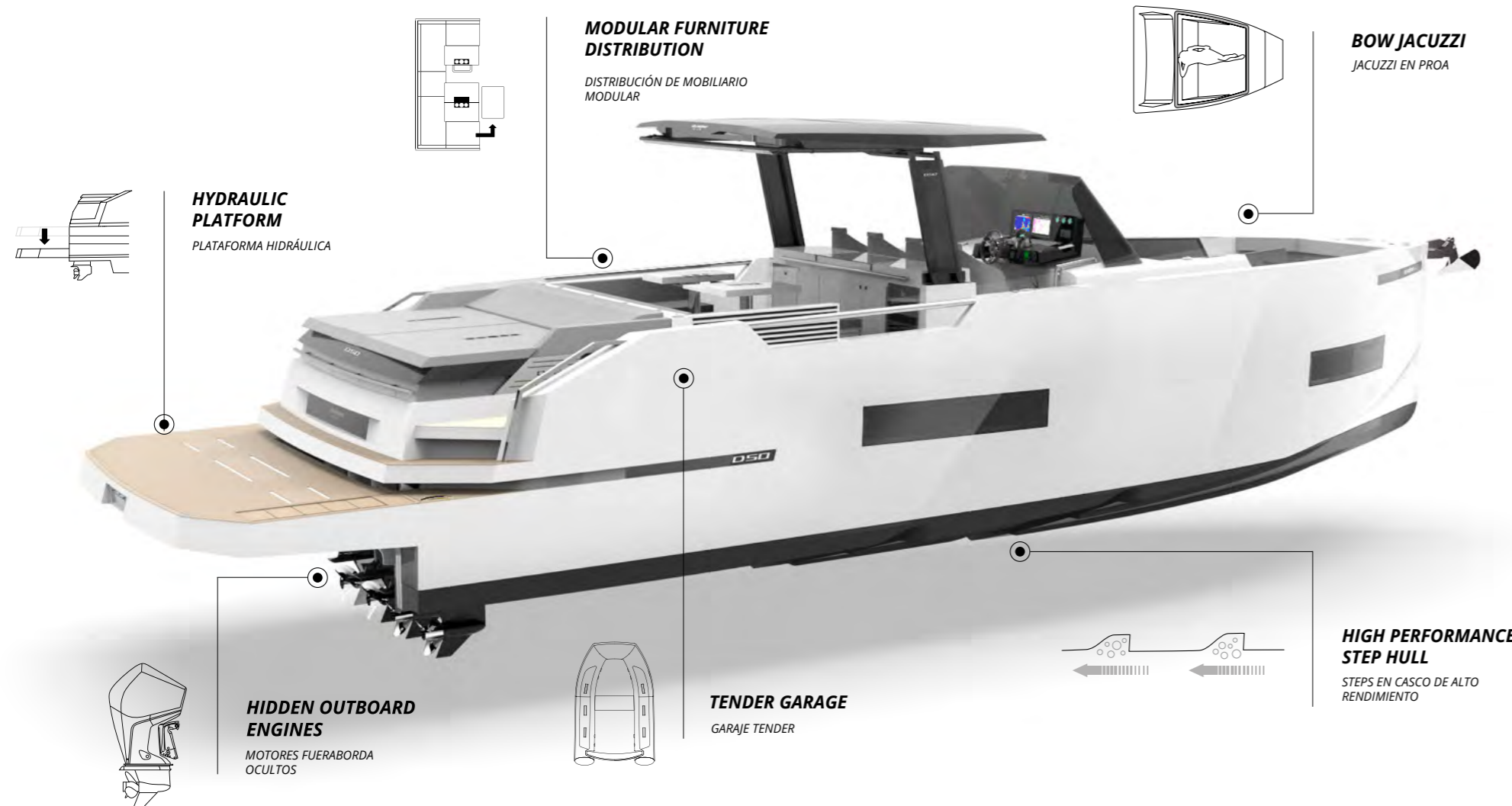

MOTORIZATION / MOTORIZACIÓN

2 X 600 HP MERCURY V-12 VERADO®	(4 STROKE) OUTBOARD / (4 TIEMPOS) FUERABORDA
4 X 300 HP MERCURY V-8 VERADO®	(4 STROKE) OUTBOARD / (4 TIEMPOS) FUERABORDA
4 X 350 HP MERCURY V-10 VERADO®	(4 STROKE) OUTBOARD / (4 TIEMPOS) FUERABORDA
4 X 400 HP MERCURY V-10 VERADO®	(4 STROKE) OUTBOARD / (4 TIEMPOS) FUERABORDA

ACTIVE TRIM MERCURY MARINE
JOYSTICK PILOTING SYSTEM (JPO) MERCURY (OPTIONAL)

STANDARD EQUIPMENT / EQUIPAMIENTO DE SERIE

WHITE COLOR HULL	CASCO COLOR BLANCO
ARTIFICIAL TEAK DECK FLEXITEEK® SCRUBBED WITH BLACK LINES	CUBIERTA DE TECA SINTÉTICA FLEXITEEK® SCRUBBED Y LÍNEAS NEGRAS
ANCHOR SUPPORT, ANCHOR, CHAIN AND ELECTRIC WINCH	SOPORTE DE ANCLA, ANCLA, CADENA Y MOLINETE ELÉCTRICO
SOFT-TOP	SOFT -TOP
LED NAVIGATION LIGHTS LOPOLIGHT®	LUCES DE NAVEGACIÓN LED LOPOLIGHT®
LED DECORATIVE LIGHTS ON DECK	LUCES DECORATIVAS LED EN CUBIERTA
TWO TABLES ON DECK	DOS MESAS EN CUBIERTA
SWIMMING LADDER	ESCALERA DE BAÑO
CARBON TRIMS ON BOWS AND SIDES	EMBELLECEDORES DE CARBONO EN LAS AMURAS Y COSTADOS
FLAGPOLE	ASTA DE BANDERA
RETRACTABLE CLEATS IN ALUMINIUM	CORNAMUSAS RETRÁCTILES DE ALUMINIO
EXTERIOR KITCHEN (FRIDGE, SINK, CERAMIC COOKTOP, MICROWAVE)	COCINA (NEVERA, FREGADERO, VITROCERÁMICA, MICROONDAS)
CUSHIONS AND UPHOLSTERY MORBERN SUNDANCE® HERM	COJINES Y TAPICERÍA MORBERN SUNDANCE® HERM
AUDIO SYSTEM FUSION R470N (4 SPEAKERS)	SISTEMA DE AUDIO FUSION R470N (4 ALTAVOCES)
NAVIGATION SYSTEM SIMRAD (12")	SISTEMA DE NAVEGACIÓN SIMRAD (12")
VHF RADIO SIMRAD RS20 AND ANTENNA	RADIO VHF SIMRAD RS20 Y ANTENA
HORN	BOCINA
BILGE PUMPS	BOMBAS DE ACHIQUE
AC SHORE POWER AND CABLE / BATTERY CHARGER	TOMA DE TIERRA Y CABLE / CARGADOR DE BATERÍA
SHOWER ON DECK	DUCHA AGUA DULCE EN CUBIERTA
WINDOWS ON HULL SIDES (STERN CABIN)	VENTANAS LATERALES EN CASCO (CABINA POPA)
BOW CABIN WITH DOUBLE BED	CABINA EN PROA CON CAMA DOBLE
LIVING AREA WITH U-SHAPED SOFA CONVERTIBLE INTO DOUBLE BED	SALÓN EN POPA, SOFÁ EN FORMA DE U CONVERTIBLE EN CAMA DOBLE
COMPLETE BATHROOM (ELECTRIC WC)	BAÑO COMPLETO (WC ELÉCTRICO)
USB AND LIGHTER PLUG OUTLET 12V	ENCHUFE 12V (USB Y MECHERO)



2 cabins + Modular distribution **opt.** 1 living room



2 cabins + Modular distribution **opt.** 2 bedroom



2 cabins + 2 bathrooms (optional)





D50

C O U P É

The D50 Coupé is the latest model in the range, a design that exceeds all expectations in its length and re-invents the walkaround concept.

Based on the D50 Open, it maintains its impressive navigation performance with hidden outboards and the characteristic and generous spaces both on deck and inside. This new version with a slim superstructure further highlights its avant-garde architecture by offering its occupants a closed driving area for greater comfort on long journeys and allowing its central part to be opened with the retractable canvas roof.

Sporty, modern, spacious and convertible, that's the D50 Coupé.

El D50 Coupé es el último modelo de la gama, un diseño que supera todas las expectativas en su eslora y reinventa el concepto walkaround.

Basado en el D50 Open, mantiene sus impresionantes prestaciones de navegación con motores fueraborda ocultos y los característicos y generosos espacios tanto en cubierta como en el interior. Esta nueva versión con una estilizada superestructura resalta aún más su arquitectura vanguardista ofreciendo a sus ocupantes una zona de conducción cerrada para mayor confort en trayectos largos y permitiendo en su parte central abrirse con el techo retráctil de lona.

Deportivo, moderno, espacioso y cabrio, así es el D50 Coupé.

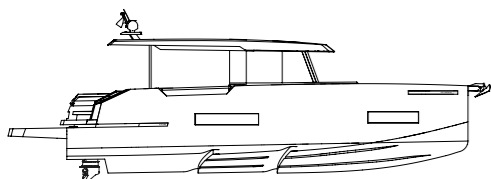



TECHNICAL SPECIFICATIONS / ESPECIFICACIONES TÉCNICAS

LENGTH OVERALL / <i>ESLORA TOTAL</i>	13,10 m	MINIMUM POWER / <i>POTENCIA MÍNIMA</i>	1.200 HP
LENGTH OVERALL WITH PLATFORM OPTION / <i>ESLORA TOTAL CON PLATAFORMA OPCIONAL</i>	14,90 m	MAXIMUM POWER / <i>POTENCIA MÁXIMA</i>	1.600 HP
BEAM / <i>MANGA</i>	4,40 m	FUEL TANK / <i>DEPÓSITO DE COMBUSTIBLE</i>	1.500 L
DEPTH / <i>CALADO</i>	0,70 m	WATER TANK / <i>DEPÓSITO DE AGUA DULCE</i>	350 L
PASSENGERS / <i>OCUPANTES</i>	12 pax	DISPLACEMENT / <i>DESPLAZAMIENTO</i>	12.000 Kg
OUTBOARD ENGINES / <i>MOTORES FUERABORDA</i>	2 o 4 uds.		

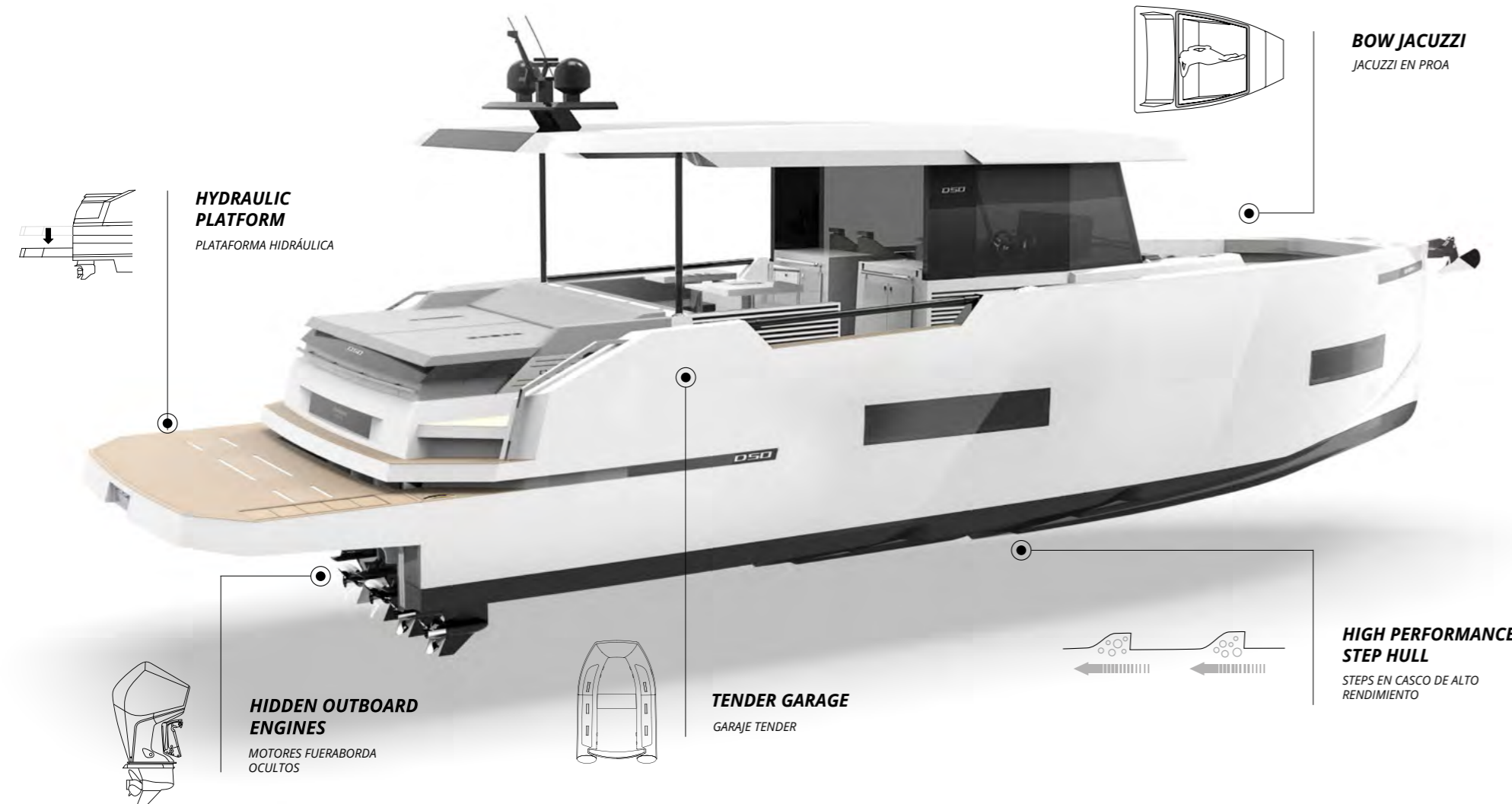

MOTORIZATION / MOTORIZACIÓN

2 X 600 HP MERCURY V-12 VERADO®	(4 STROKE) OUTBOARD / (4 TIEMPOS) FUERABORDA
4 X 300 HP MERCURY V-8 VERADO®	(4 STROKE) OUTBOARD / (4 TIEMPOS) FUERABORDA
4 X 350 HP MERCURY V-10 VERADO®	(4 STROKE) OUTBOARD / (4 TIEMPOS) FUERABORDA
4 X 400 HP MERCURY V-10 VERADO®	(4 STROKE) OUTBOARD / (4 TIEMPOS) FUERABORDA
ACTIVE TRIM MERCURY MARINE	
JOYSTICK PILOTING SYSTEM (JPO) MERCURY (OPTIONAL)	

STANDARD EQUIPMENT / EQUIPAMIENTO DE SERIE

WHITE COLOR HULL	CASCO COLOR BLANCO
ARTIFICIAL TEAK DECK FLEXITEEK® SCRUBBED WITH BLACK LINES	CUBIERTA DE TECA SINTÉTICA FLEXITEEK® SCRUBBED Y LÍNEAS NEGRAS
ANCHOR SUPPORT, ANCHOR, CHAIN AND ELECTRIC WINCH	SOPORTE DE ANCLA, ANCLA, CADENA Y MOLINETE ELÉCTRICO
LED NAVIGATION LIGHTS LOPOLIGHT®	LUCES DE NAVEGACIÓN LED LOPOLIGHT®
LED DECORATIVE LIGHTS ON DECK	LUCES DECORATIVAS LED EN CUBIERTA
TWO TABLES ON DECK	DOS MESAS EN CUBIERTA
SWIMMING LADDER	ESCALERA DE BAÑO
CARBON TRIMS ON BOWS AND SIDES	EMBELLECEDORES DE CARBONO EN LAS AMURAS Y COSTADOS
FLAGPOLE	ASTA DE BANDERA
RETRACTABLE CLEATS IN ALUMINIUM	CORNAMUSAS RETRACTILES DE ALUMINIO
EXTERIOR KITCHEN (FRIDGE, SINK, CERAMIC COOKTOP, MICROWAVE)	COCINA (NEVERA, FREGADERO, VITROCERÁMICA, MICROONDAS)
CUSHIONS AND UPHOLSTERY MORBERN SUNDANCE® HERM	COJINES Y TAPICERÍA MORBERN SUNDANCE® HERM
AUDIO SYSTEM FUSION R470N (4 SPEAKERS)	SISTEMA DE AUDIO FUSION R470N (4 ALTAVOCES)
NAVIGATION SYSTEM SIMRAD (12")	SISTEMA DE NAVEGACIÓN SIMRAD (12")
VHF RADIO SIMRAD RS20 AND ANTENNA	RADIO VHF SIMRAD RS20 Y ANTENA
HORN	BOCINA
BILGE PUMPS	BOMBAS DE ACHIQUE
AC SHORE POWER AND CABLE / BATTERY CHARGER	TOMA DE TIERRA Y CABLE / CARGADOR DE BATERÍA
SHOWER ON DECK	DUCHA AGUA DULCE EN CUBIERTA
WINDOWS ON HULL SIDES (STERN CABIN)	VENTANAS LATERALES EN CASCO (CABINA POPA)
BOW CABIN WITH DOUBLE BED	CABINA EN PROA CON CAMA DOBLE
LIVING AREA WITH U-SHAPED SOFA CONVERTIBLE INTO DOUBLE BED	SALÓN EN POPA, SOFÁ EN FORMA DE U CONVERTIBLE EN CAMA DOBLE
COMPLETE BATHROOM (ELECTRIC WC)	BAÑO COMPLETO (WC ELÉCTRICO)
USB AND LIGHTER PLUG OUTLET 12V	ENCHUFE 12V (USB Y MECHERO)



2 cabins + Modular distribution **opt.** 1 living room



2 cabins + Modular distribution **opt.** 2 bedroom



2 cabins + 2 bathrooms (optional)



2 cabins + 2 bathrooms (optional)



2 cabins + 2 bathrooms (optional)

D60

The D60 is the new flagship of De Antonio Yachts range. The yacht is a 18-meters lenth powered by four Mercury V12 600hp outboard engines, delivering speeds over 45 knots.

The design maximizes space with a walk-around concept: a stern solarium with a table and ice bucket, a central dining area for over 10 people, and a configurable bow with a solarium, sofa, and optional integrated jacuzzi. The D60 includes a versatile hardtop roof that can be fully enclosed or opened. Its innovative interior layout offers a mid-level kitchen, a spacious suite, flexible forward cabins, and a separate crew cabin. The first unit will be available in summer 2025.

El D60 es el nuevo buque insignia de la gama De Antonio Yachts. El yate tiene una longitud de 18 metros y está propulsado por cuatro motores fueraborda Mercury V12 de 600 hp, alcanzando velocidades de más de 45 nudos.

El diseño maximiza el espacio con un concepto walk-around: un solárium en la popa con una mesa y cubitera, una zona de comedor central para más de 10 personas, y una proa configurable con un solárium, sofá y jacuzzi integrado opcional. El D60 incluye un techo rígido versátil que puede estar completamente cerrado o abierto. Su innovador diseño interior ofrece una cocina a nivel intermedio, una suite espaciosa, camarotes delanteros flexibles y un camarote separado para la tripulación. La primera unidad estará disponible en el verano de 2025.

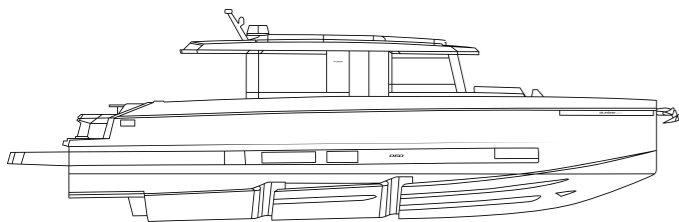





TECHNICAL SPECIFICATIONS / ESPECIFICACIONES TÉCNICAS

LENGTH OVERALL WITH PLATFORM OPTION / ESlORA TOTAL CON PLATAFORMA OPCIONAL	18,50 m	PASSENGERS / OCUPANTES	12 pax
BEAM / MANGA	5,25 m	MAXIMUM POWER / POTENCIA MÁXIMA	2.400 HP
DEPTH / CALADO	1,00 m		



Bow hard top sun deck **std.**



Bow hard top sliding glass roof **opt.**



Deck layout



Bow 2 twin cabins **std.**



Bow double cabin **opt.**



MORE DETAILS / MÁS DETALLES

CUSTOMIZATION/ PERSONALIZACIÓN

It's time to customize your dream boat. Choose from our wide variety of colours combinations from top suppliers and make your De Antonio Yachts according to your individual wishes. Your boat, your style.

Es hora de personalizar el barco de sus sueños. Elija entre nuestra amplia variedad de combinaciones de colores de los principales proveedores y cree su De Antonio Yachts de acuerdo con sus deseos. Su barco, su estilo.

UPHOLSTERY COLOURS / COLORES DE TAPICERÍA MORBERN SUNDANCE®



HERM (Standard) SILVER ASH KHAKI NATURAL CRUSH RED SIESTA KEY RAIN NIGHTFALL

UPHOLSTERY FINISHES / ACABADOS DE TAPICERÍA

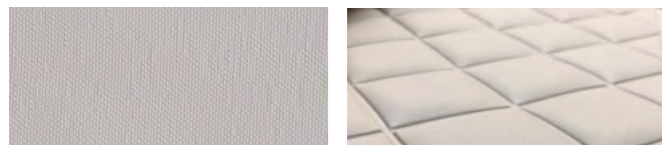

STANDARD

PREMIUM

TEAK / TECA FLEXITEEK®

Choose your best teak and line color combination from the different options / *Elija la mejor combinación de color de teca y línea entre las distintas opciones.*



SCRUBBED black, white & grey caulking (Black caulking standard)
BLEACHED black, white & grey caulking
TEAK black, white & grey caulking
WEATHERED black, white & grey caulking
GREY black & white caulking

GELCOAT OPTIONS / OPCIONES DE GELCOAT



WHITE (Standard) LIGHT GREY DUSTY GREY



SPAIN

BARCELONA & TARRAGONA DRACO SERVICIOS NÁUTICOS	COSTA BRAVA SUR NÀUTICA CASAS	COSTA BRAVA NORTE NAUTIVELA	ANDALUCÍA HIGUERÓN YACHTS	MALLORCA CRISTAL YACHTS	GALICIA YATESPORT, SAU
Calle Dr. Fleming 6, bajos 08017 Barcelona alvaro@deantonioyachts.com +34 938 32 33 33	Av. de Castell d'Aro,114 17250 Platja d'Aro info@nauticacasas.com +34 972 81 76 12	C. d'Orriols a l'Escala, km 16,6 17137 Viladamat nautivela@nautivela.net +34 972 78 83 64 +34 972 45 18 18	Av. Del Higuera 48 29640 Fuengirola - Málaga andalucia@deantonioyachts.com +34 609 00 86 80	Port Calanova Av. Juan Miró 37 07015 Palma de Mallorca mallorca@deantonioyachts.com +34 620 28 32 12	Bajada a Lagoa S/N, 36207 Vigo, España info@yatesport.es +34 986 374 305

MENORCA NAUTIC CENTER MENORCA	IBIZA & FORMENTERA RENT ME BOAT	VALENCIA PLEAMAR 24 NUDOS	DENIA PLEAMAR 24 NUDOS	MURCIA PLEAMAR 24 NUDOS
Calle S´ Esperó, 16 - Poima 07714 Mahón - Menorca menorca@nauticcenter.es +34 971 35 44 99	Paseo Juan Carlos I no. 23, local 10 Edificio Mediterráneo - 07800 Ibiza ibiza@deantonioyachts.com +34 609 71 00 30	Real Club Náutico de Valencia, Local 14 Camino del Canal, 91 46024 Valencia nauticservices@nauticservices.es +34 615 08 10 81	Marina de Denia Edificio D, local 2 03700 Denia comercial@pleamar.net +34 966 43 54 52	C.N Dos Mares Polígono Dos Mares, 37 30380 La Manga del Mar Menor narcisoblaya@gmail.com +34 868 08 46 40

FRANCE

SAINT TROPEZ - THEOULE SUR MER OMV - MERCURIO	CANNES - NIZA EVASION YACHTING	MARSEILLE - CAVALAIRE SUR MER EVASION YACHTING	CORSE UNION NAUTIQUE	CÔTE ATLANTIQUE EVASION PRO YACHTING
319 Route des Blaquieres Bp 10 83310 Grimaud info@omv.fr +33 (0) 4 94 555 333	13, Quai Aristide Briand, 83 430 Saint-Mandrier sur Mer info@evasion-yachting.com +33 (0)4 94 63 00 00	13, Quai Aristide Briand, 83 430 Saint-Mandrier sur Mer info@evasion-yachting.com +33 (0)4 94 63 00 00	Port de l'Amirauté 20090 Ajaccio corse@deantonioyachts.com +33 (0)4 95 20 66 31	N8 Quai Goslar 33120 Arcachon arcachon@proyachting.net +33 5 64 52 00 00

ITALY

CENTRALE PEDETTI YACHT SALES	TRIVENETO PEDETTI YACHT SALES	LAZIO, MARCHE ABRUZZO PEDETTI YACHT SALES	CAMPANIA PEDETTI YACHT SALES	SICILIA, CALABRIA PEDETTI YACHT SALES
Porto Turistico di Lavagna, box 102 16033 Lavagna (GE) info@pedettiyacht.com dpedetti@pedettiyacht.com +39 0185 370164	Via del Coregolo 32 33053, Aprilia Marittima (UD) amichelazzo@pedettiyacht.com +39 3472 234548	Marina di Nettuno, box 11 00048 Nettuno (LT) nettuno@pedettiyacht.com +39 3924 797325	Via G. Cesare 86 80070 Bacoli (NA) info@nauticafusaro.com +39 0818 689015	Marina di Portorosa, via Prestipaolo 98054 Furnari (ME) siciliamare@siciliamare.it +39 337 886571

FLORIDA, BAHAMAS, TURKS & CAICOS, CAYMAN ISLANDS, PUERTO RICO, BRITISH VIRGIN ISLANDS

MIAMI
DE ANTONIO YACHTS MIAMI

RMK Merrill Stevens North Office
1270 NW 11th St 33125 Miami
sales@deantonioyachtsmiami.com
+1 (305) 921 9062

PORTUGAL

LISBOA
Y.I. YACHT INTERNATIONAL

Edf SGC, estrada de Alfragide 67
2610-008 Lisboa, Portugal
deantonioyachts@yb-nauticgroup.com
+351 91 998 2530

GERMANY

OFFENBACH AM MAIN
BAOTIC YACHTING GMBH

Andréstraße 2
63067 Offenbach am Main
info@baotic-yachting.de
+ 49 (0) 69 829 78 80

AUSTRIA

OFFENBACH AM MAIN
BAOTIC YACHTING

Andréstrasse 2
63067 Offenbach am Main
info@baotic-yachting.de
+49 (0) 69 829 78 80

GREECE

ELLINIKO-ATHENS
ATALANTA MARINE

3 Iosifidou Street
167 77 Elliniko – Athens
shipyards@atalantamarine.com
+30 210 991 0722

SWITZERLAND

LEMAN LAKE
WOOD AND BOAT

24 route de Compois
1252 Meinier GE
a.lepine@deantonioyachts.com
+41 (0)22 752 67 78

SAUDI ARABIA

JEDDAH
SAMACO MARINE

P.O. BOX #126417
King Fahad road, Al Nahdah District
21352 Jeddah
s.marine@samaco.com.sa
+96 612 699 23 00

BRASIL

JACUECANGA
Y.I. YACHT INTERNATIONAL

Av. Winston Maruca, s/n, Lote 30 A/B
Angra dos Reis - RJ - Zip Code 23.914-345
deantonioyachts@yb-nauticgroup.com
+55 24 998 142 481

MALDIVES

GALADHUN GOLHI
OCEAN GROUP PVT.LTD

P.O. BOX #126417
H.Kudhilunboamaage I Galadhun Golhi
Republic of Maldives, 20013
hussain@oceangroup.mv
+(65) 85687888

HUNGARY

BUDAPEST
High line yachting Group Kft (E-Hajó Center)

Hungary, 1032 Budapest,
Bécsi út 189. 1. em 3. ajtó
Info@highlineyachting.hu
+36202619260

CROATIA

SEGET DONJI
YACHT CENTAR BAOTIC D.O.O.
MARINA BAOTIC

Don Petra Spike 2A 21218 Seget Donji
info@baotic-yachting.de
+ 49 (0) 69 829 78 80

TURKEY

BODRUM
BODRUM MARINE GROUP

Düzalan Cad, Ortakent Mah
A Blok, No: 94-1/1, Bodrum
info@bodrummarinegroup.com
+90 252 358 7091

MALTA

QORMI
STRAND MARINE & AUTO SYSTEMS LTD

Valdor Bldgs, Triq is-Sebh, Qormi
QRM 9055, Malta
+356 99 209 690

BAHRAIN

KINGDOM OF BAHRAIN
DE ANTONIO YACHTS BAHRAIN

bahrain@deantonioyachts.com
+973 36838300

KUWAIT & UAE

JEDDAH
SAMACO MARINE

P.O. BOX #126417
King Fahad road, Al Nahdah District
21352 Jeddah
s.marine@samaco.com.sa
+96 612 699 23 00

AUSTRALIA

FREMANTLE
BOATINGCO

6/24 Mews Road, South Fremantle
Western Australia 6162
steve.marris@boatingco.com.au
+61 430 118 442

CHINA

HONG KONG

SUN AZURE LTD 22/f Jonsim place
228 Queen's road
East Wanchai, Hong Kong.
nhl48j@aol.com
+85262765290

SLOVENIA

ZAGREB
YACHT CENTAR BAOTIC D.O.O.

Maksimirska 282, 10 000 Zagreb
info@baotic-yachting.de
+49 (0) 69 829 78 80

MONACO

MONACO
HQ DE ANTONIO YACHTS

C/ del Avenir 8
08006 Barcelona
sales@deantonioyachts.com
+34 93 467 60 36

UNITED KINGDOM

POOLE
THE BOAT CLUB SALES LTD

Parkstone Bay Marina, Turks Lane,
Poole, Dorset, BH14 8EW
info@theboatclub.com
+44 (0)1202 724912

CYPRUS

LIMASSOL
ATALANTA MARINE

3 Iosifidou Street
167 77 Elliniko – Athens
shipyards@atalantamarine.com
+30 210 991 0722

MEXICO

MEXICO CITY
PERFORMANCE BOATS MEXICO

Antonio Dovali Jaime 75 PB Lomas de Santa Fe
C.P.01219, Mexico City
ventas@pbt.com
+52 55 5293 0563

CANADA

QUEBEC
HQ DE ANTONIO YACHTS

C/ del Avenir 8
08006 Barcelona
sales@deantonioyachts

TH, SG, MY, ID

FLOW YACHT CLUB

1 Ratchadapisek Rd., Bangpongpan,
Yannawa, Bangkok 10120 THAILAND
info@flowyacht.club
+66 96 55 99 554

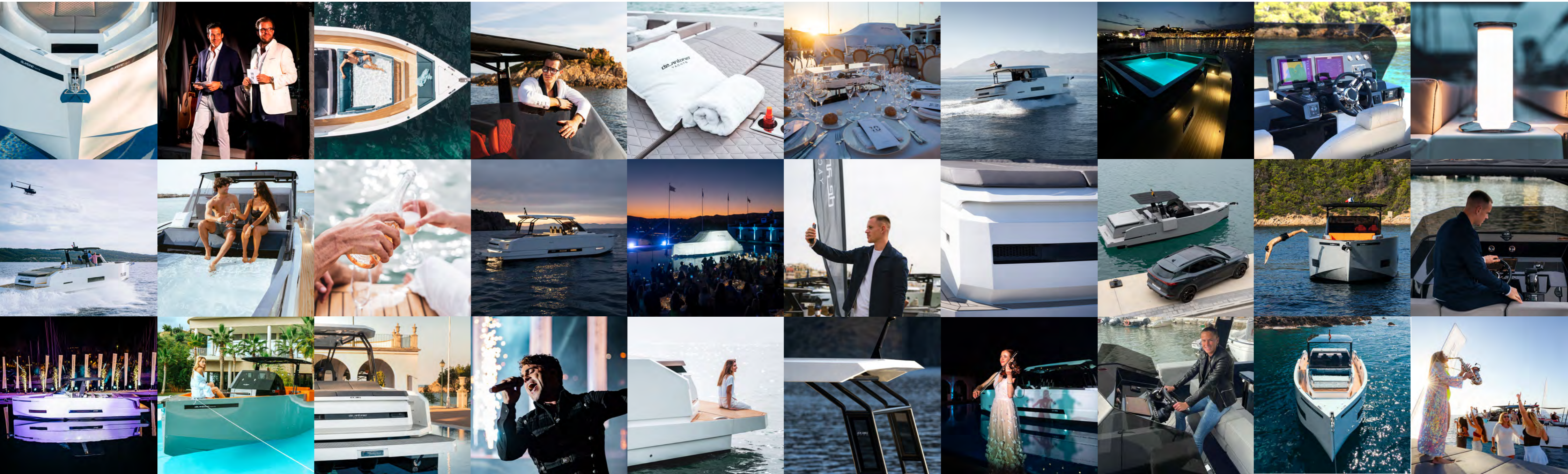



#DeAntonioYachts

www.deantonioyachts.com

2024 ©De Antonio Yachts S.L.